

**BWD1100W  
Washer dryer**

**Instruction manual**

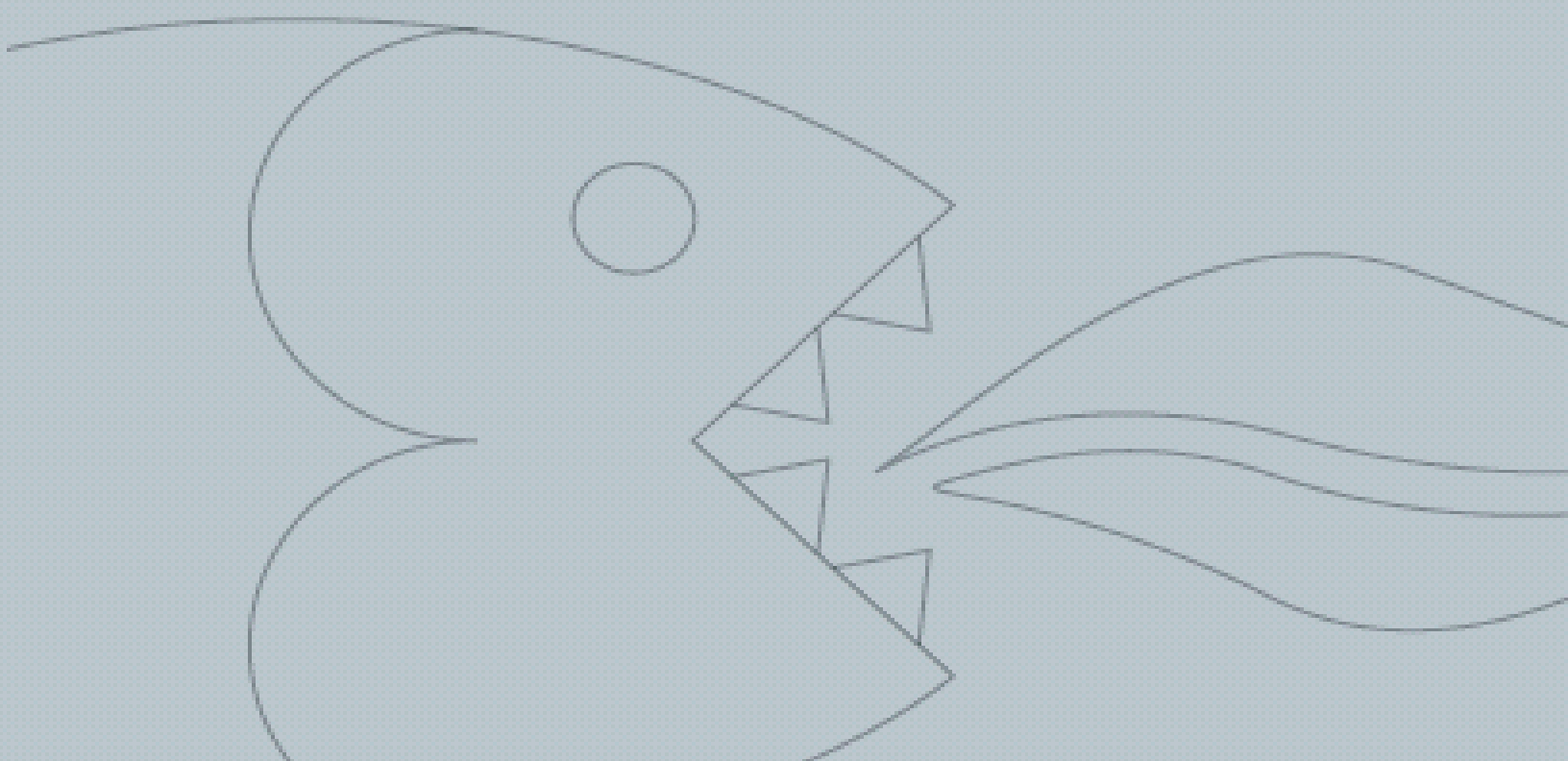

# USER MANUAL FOR YOUR BAUMATIC

## BWD1100W Washer dryer



  
**Baumatic®**  

---

*You will be mine ...*

***NOTE:*** *This User Instruction Manual contains important information, including safety & installation points, which will enable you to get the most out of your appliance. Please keep it in a safe place so that it is easily available for future reference; for you or any person not familiar with the operation of the appliance.*

DD 01/10/07

# Contents

<b>Environmental note</b>	4
<b>Important safety information</b>	5 – 6
<b>Specifications</b>	7
Description of the appliance	8
Control panel	9
Program options	9
LCD display	10
Wash program selection knob	10
Spin speed selection knob	10
Detergent drawer	11
<b>Preparing the wash cycle</b>	12
Preparing your garments for washing	12
A selection of wash care symbols	13
Detergents and conditioners	14
<b>Program table</b>	15
Wash program guidance	16
Selecting a wash program	17 – 18
Selecting a separate drying program	18
Selecting an automatic wash and dry program	19
Cancelling or pausing a wash program	19 – 20
Spin speed selection knob	20 – 21
Setting a program option	21
<b>Maintenance and cleaning</b>	22
In daily use	22
Control panel and washer dryer cabinet	22
Detergent drawer	22 – 23
The washer dryer drum	23
Door	23
<b>Error code failure system</b>	24 – 25
General troubleshooting	25
Poor wash results	26
Cleaning the drain pump filter	27 – 28
<b>Installation</b>	28
Unpacking the machine and removing the transit bolts	28 – 29
Positioning and levelling the appliance	30
Connecting to the mains water supply	31
Water outlet	32
Power supply	33
Before first use maintenance wash	34
<b>Contact details</b>	35

## ENVIRONMENTAL NOTE

**Note:** Before discarding an old appliance, switch off and disconnect it from the power supply. Cut off and render any plug useless. Cut the cable off directly behind the appliance to prevent misuse. This should be undertaken by a competent person. Disable the door lock to make sure that children cannot get stuck inside the appliance.

This appliance is marked according to the European directive 2002/96/EC on Waste electrical and Electronic Equipment (WEEE). By ensuring this product is disposed of correctly, you will help prevent potential negative consequences for the environment and human health, which could otherwise be caused by inappropriate waste handling of this product.

The symbol  on the product, or on the documents accompanying the product, indicates that this appliance may not be treated as household waste. Instead it shall be handed over to the applicable collection point for the recycling of electrical and electronic equipment.

Disposal must be carried out in accordance with local environmental regulations for waste disposal.

For more detailed information about treatment, recovery and recycling of this product, please contact your local city office, your household waste disposal service or the shop where you purchased the product.



## IMPORTANT SAFETY INFORMATION



Your safety is of the utmost importance to Baumatic. Please make sure that you read this instruction booklet **before** attempting to install or use the appliance. If you are unsure of any of the information contained in this booklet, please contact the Baumatic Technical Department.

### General Safety

- Repairs to your appliance must only be carried out by a Baumatic engineer or one of its authorized service agents. Any attempt by an inexperienced person to repair the appliance, could result in injury or damage to your washing machine.
- If you notice that the mains cable is damaged. **The appliance must not be used.** The same applies if you notice that the worktop, control panel or base area is damaged. As this could allow access to the internal components of the machine.
- The appliance should be turned off and isolated from the mains supply, before either cleaning or maintenance work is attempted.
- The mains cable must not be used to pull the plug out of the electrical socket.
- The machine should not be sprayed with water.
- The glass of the porthole door may become hot during the higher temperature wash programs.
- The machine should be allowed to cool before carrying out an emergency drain or cleaning the drain filter.
- It is possible for small animals to chew either mains cables or water hoses, which could cause an electric shock hazard.

### Installation

- The installation instructions contained within this user manual should be followed.
- It is obligatory for the completed installation to comply with all relevant building regulations and local water authority requirements.

- **Before the first use of the appliance, we advise that a 95 degree cotton wash is completed. No garments should be placed inside the machine; however a small amount of detergent must be used.**

## **During Use**

- It is recommended that the appliance is unplugged and the water supply is turned off after the machine is used.
- This appliance is only designed to wash normal domestic washloads. If you use your washing machine in any other way or it is incorrectly used, then Baumatic accepts no liability for any damage that might be caused and any guarantee will be void.
- No attempt should be made to alter or modify the specifications of this appliance.
- The detergents that you place in this appliance should be suitable for automatic washing machines. With regards to dosage levels, the detergent manufacturer's recommendations should be followed.
- You should not wash garments that have been in contact with flammable materials.
- Your washing machine should not be used for dry cleaning.
- If you use either dyes or bleaching agents inside this machine, then you should consult with the manufacturer of these products to make sure they are suitable for use in your washing machine. Baumatic cannot be held responsible for any damage that may result.

## **Child Safety**

- Your washing machine should only be used by adults. You should not allow children in the area of the machine unsupervised. You should not let them touch the controls or play with the appliance.
- It could be possible for a child or pet to gain access to the washing machine through the porthole door. Therefore please check the drum before using the appliance.
- Any packaging that is removed from the machine should be kept away from children.
- All detergents should be kept out of children's reach in a safe place.

## Specifications

- ✓ 13 wash programs/2 drying programs
- ✓ 6kg wash load/4kg drying load
- ✓ 1100 rpm maximum spin speed
- ✓ LCD display
- ✓ Electronic control
- ✓ Spin speed regulation via a control knob
- ✓ Remain time indicator
- ✓ **3 Option buttons:**      Easy iron  
   Extra rinse  
   Intensive wash
- ✓ Unbalance control system
- ✓ Suspend the clothes in water option
- ✓ Door safety lock
- ✓ Stainless steel drum
- ✓ Adjustable feet
- ✓ Error code failure system

### Appliance dimensions

Height:      850 mm

Width:        590 mm

Depth:       550 mm

### Energy efficiency

Energy rating (washing)      A

Energy rating (drying)        B

Wash performance              A

Water extraction performance   C

## Description of the appliance

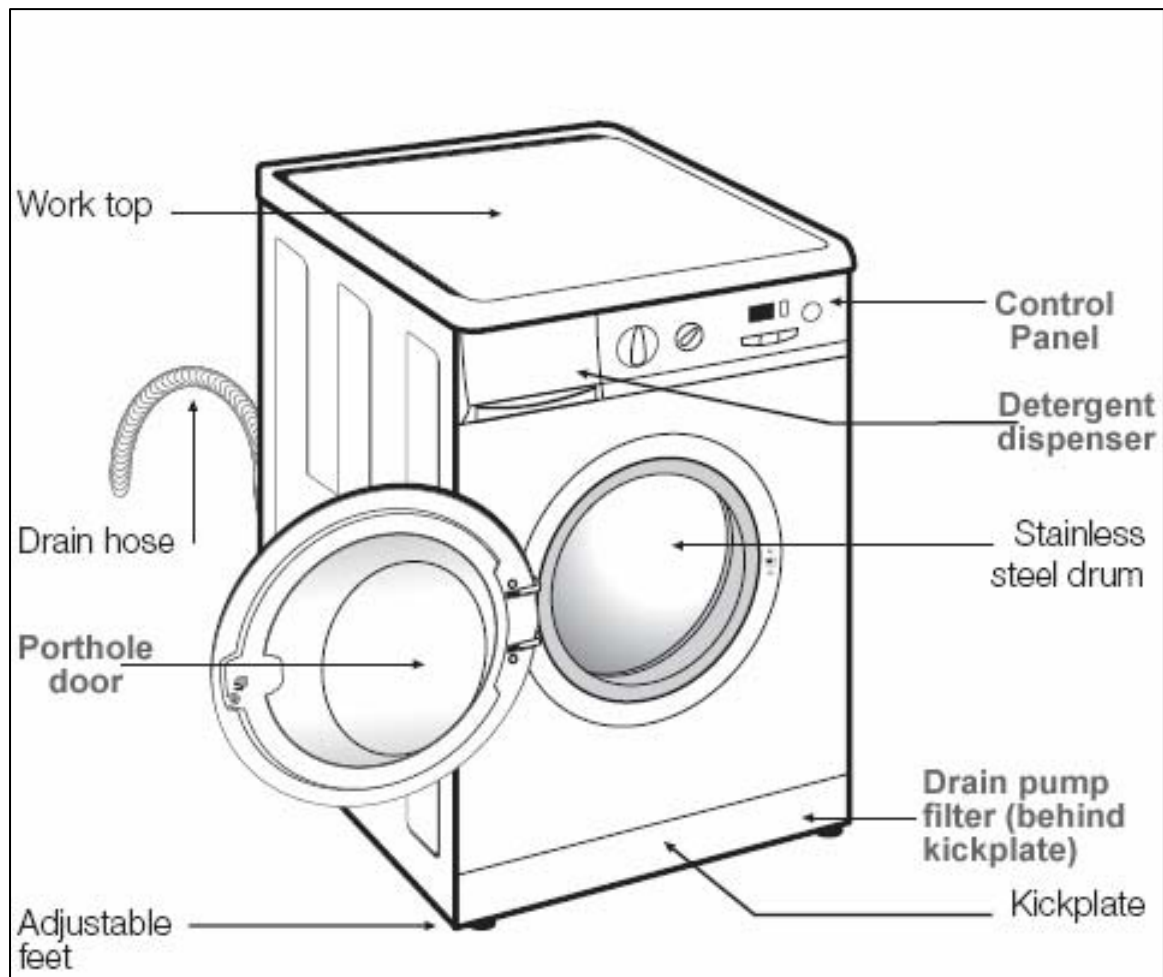

## Control panel

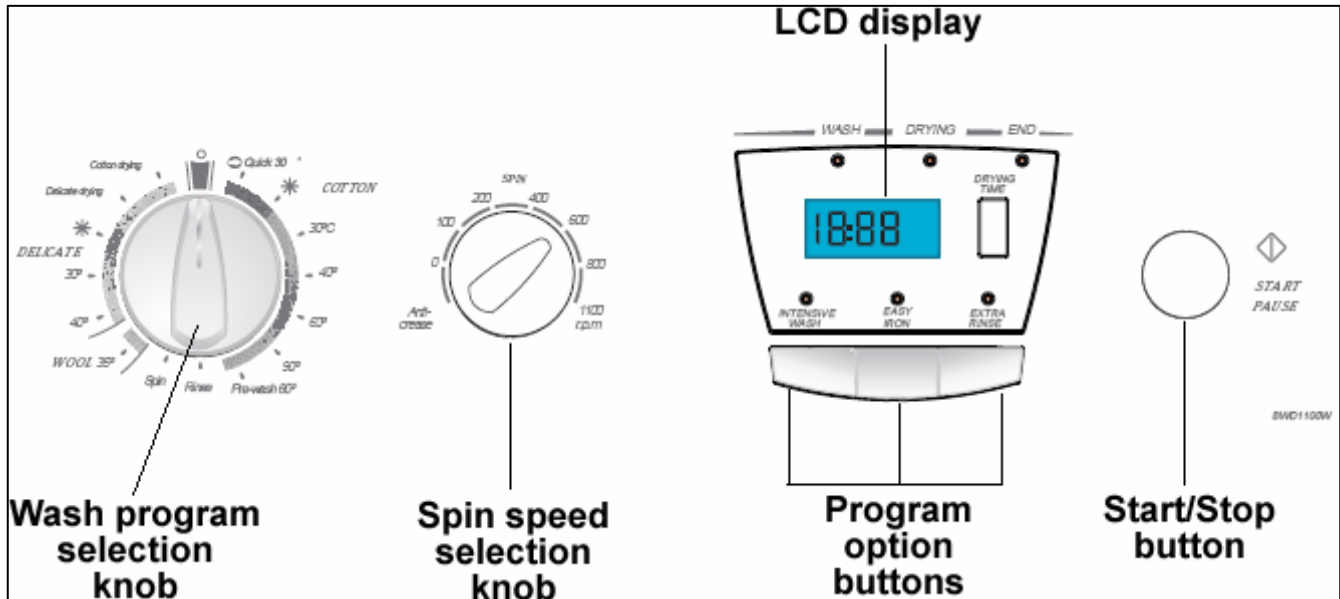

### Wash program selection knob

This control knob allows you to select the wash program of your choice.

### Start/Stop button

Once a wash program has been selected, this button should be pressed to start the wash cycle.

### Program option button

**This button needs to be pressed after a wash program has been selected, but before the wash program has been started. If you select a different wash cycle after pressing a program option, it will need to be reselected.**

**Intensive wash:** This function should be selected if you are washing heavily soiled, stained clothes. It achieves a better level of wash performance by extending the wash program that you have selected.

**Easy iron:** This function helps to prevent garments from creasing by carrying out a program where the rotation of the drum will fluff out the garments, after the spin cycle has completed. This should make the garments easier to iron.

**Extra rinse:** This function increases the level of the final rinse for the selected wash program. This should be selected if large loads are being washed or the garments belong to somebody who has sensitive skin. This option will increase the amount of water the appliance uses.

## LCD display

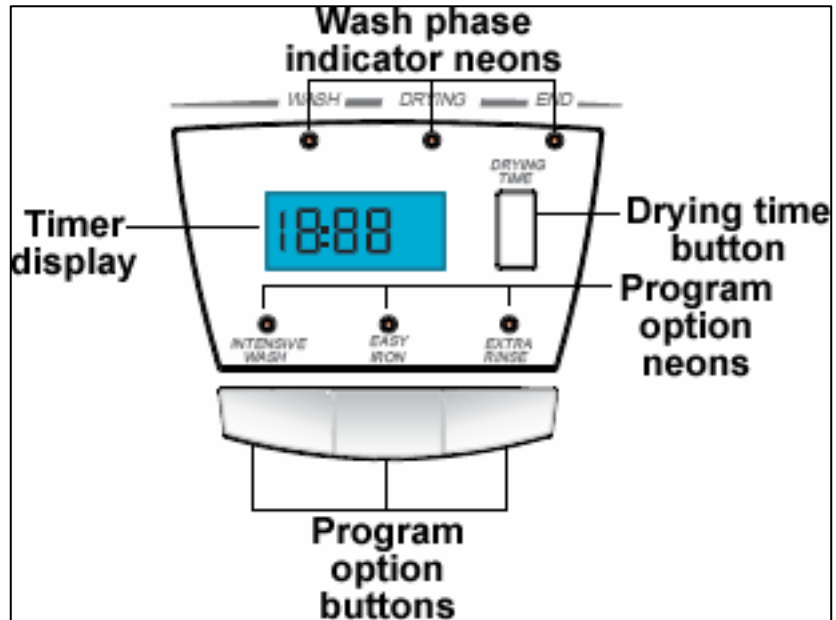

## Wash program selection knob

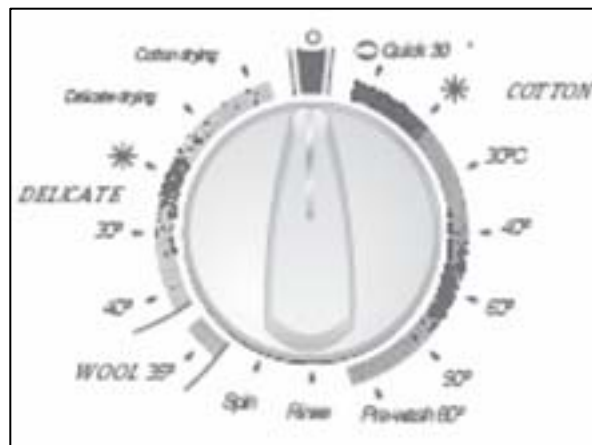

## Spin speed selection knob

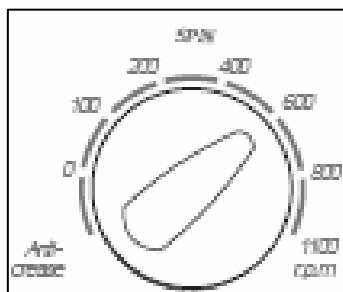

## Detergent drawer

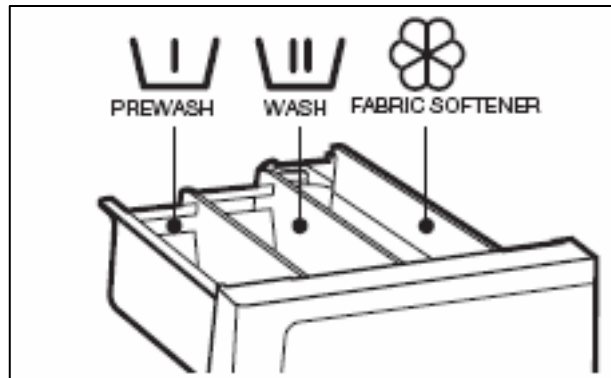

### Pre wash section

This compartment should have detergent placed in, if you are going to select a wash program that has a pre wash as part of it.

### Main wash section

This compartment should have detergent placed in it (you should also put a water softening agent in this section, if you use one). The detergent will be added to the drum at the start of the main wash program.

### Conditioner section

This compartment should be used for liquid conditioners (fabric softener, starch). They will be added to the wash load during the final rinse.

## Preparing the wash cycle

### Preparing your garments for washing

- Your washing should be sorted out, according to the fabric type and the wash care symbol that is printed on the garment's wash care label. (see separate section on wash care symbols).



- Your washing should also be sorted out according to the degree of soiling.

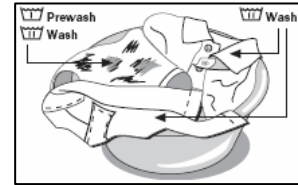



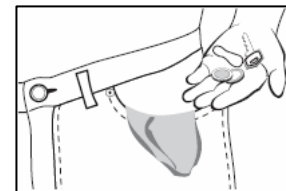

















- Check all pockets on a garment to make sure that they are empty.
- Remove any detachable metal items (badges, paperclips, safety pins etc).



- Zips should be closed, duvet covers and pillow cases should be buttoned up and any loose straps should be tied up. This will help to prevent other garments from getting damaged during the wash.
- Woollens and knitted coloured fabrics should be turned inside out before being washed in the appliance.
- Small delicate items (tights, baby socks) should be placed in either a washing net or a zipped pillow case.
- Curtains should be handled with particular care. All plastic hooks or metal strips must be removed before being washed in the appliance.
- Coloured items and whites should be washed in separate wash cycles.
- New garments often contain an excess of dye, therefore it is advisable to wash them separately for their first wash.
- Garments should be unfolded and shook out before being placed inside the machine.



## A selection of wash care symbols

I. Washing	boiling temp. 95°C	normal temp. 60°C	normal temp. 40°C	Do not wasch!
				
	delicate		manual	
II. Dry cleaning				Do not clean!
	all solvents	all but TRI	Benzine only	
				
III. Spin dryer	normal	low	high	Do not dry!
				
				Do not iron!
IV. Ironing	110°C	150°C	200°C	
				
	 Select a programme taking into account the care labels indications.			

- The wash care symbols should be used to help you to select the most suitable wash program. They will also help you to sort your laundry into different loads, depending on the fabric type and the highest temperature which the garment can be washed at.
- If the wash care label does not appear in the above table, then please refer to the washing machine program chart. This gives more detailed descriptions of the types of fabric that are suitable to be washed using a particular wash program.

## Detergents and conditioners

The amount of detergent that you need to use in your appliance, will depend on

- **The degree of soiling.** Lightly soiled garments in general require less detergent.
- **The size of the wash load.** A smaller wash load will require a reduction in the amount of detergent.
- **The hardness of your tap water.** The harder your water is, then the more detergent you will need to use. The detergent manufacturers normally give guidance as to how much extra detergent should be used, depending on the hardness of the water.

### Liquid detergent

If you are using liquid detergent, then in the majority of cases the liquid should be placed inside the dosing device supplied by the detergent manufacturer. All instructions on the detergent packaging should be followed.

### Water softening agents

If your tap water is hard, then it may be prudent to utilise a water softening agent. This will help to ensure that the appliance does not become clogged with hard water deposits. You may also find that it will allow you to lessen the amount of detergent that you are using.



**When using any detergent or water softening agent, the recommendations of the manufacturers should be followed.**

Programme	Recommended temperature	Fabric type	Possible option buttons						Max load of clothes (Kg)	Wash product compartment	Programme description	Total consumption kWh/fibres	Approx. duration (minutes)
			스핀	리터	스핀	리터	스핀	리터					
1 Quick 30°C		Cotton/Linen whites/colours very light soil	YES	NO	YES	NO	YES	NO	1,5		0,20/30	30	
2 Normal cold	Cold	Cotton/Linen delicate colours very light soil	YES						6		0,15/49	60	
3 Normal 30°C		Cotton/Linen delicate colours light soil	YES						6		0,40/49	82	
4 Normal 40°C		Cotton/Linen fast colours light soil	YES						6		0,65/49	87	
5 (*) Normal 60°C		Cotton/Linen fast colours medium soil	YES						6		1,02/49	91	
6 Normal 90°C		Cotton/Linen whites heavy soil	YES						6		1,90/55	120	
7 Prewash 60°C		Cotton/Linen whites/fast colours heavy soil	YES						6		1,45/60	105	
8 Rinses	—	Cotton/cotton mix, synthetic/delicate, wool/wool mix	YES	NO	YES		YES		6		0,05/30	23	
9 Spin-drying	—	Cotton/cotton mix synthetic/delicate wool/wool mix	NO	YES	NO	NO		6		0,05/0	10		
10 Wool 35°C	WOOL 35	Wool/wool mix whites/colours light soil	YES	NO	YES		YES		1	0,60/60	40		
11 Delicate 40°C		Synthetic/cotton mix delicate colours medium soil	YES						3		0,60/55	60	
12 Delicate 30°C		Synthetic/cotton mix delicate colours light soil	YES						3		0,35/55	55	
13 Delicate cold	Cold	Synthetic/cotton mix delicate colours very light soil	YES						3		0,15/55	55	
14 Normal dry	—	Cotton/Linen	—						4			2,8/48	160
15 Delicate dry	—	Synthetic/mixed fabrics	—						3		1,8/27	100	
									1,5		1,2/26	95	

NOTE: the KWh and litre consumptions and program durations may vary depending on the type and amount of clothes being washed, your mains water pressure, etc.

(\*) Program for wash and energy consumption assessment, in accordance with standard EN60456 (press intensive wash button).

### **Wash program guidance**

- A particular program option can only be selected if the program table advises that it is possible with the wash cycle you have selected.
- The washing machine automatically selects a spin speed for a particular wash program. However it is possible to reduce the spin speed by using the spin reduction feature.
- **Important:** You should make sure that the selected spin speed is appropriate for the garments that you are washing.
- If you use the spin reduction feature, you can make the machine not go into a spin cycle. If you pick this option, then the machine will stop with water in the drum.
- **Important:** Before opening the door of the appliance, you **MUST** select the drain program to clear this water.
- The LCD display shows an approximate time for the selected wash cycle. Please note that factors external to the machine, e.g. the temperature of your water supply, your water pressure etc. can affect the time it takes for the wash cycle to complete.

## Selecting a wash program

- ✓ Load your laundry and put detergent in the relevant compartment of the soap drawer.
- ✓ Close the porthole door firmly.



- ✓ Select the most appropriate wash program for the garments that you are washing, by turning the program selector knob.

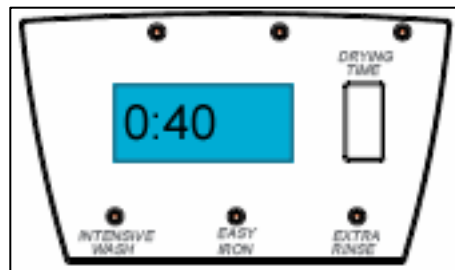

- The LCD display will briefly flash the wash program number that you have selected and then show the approximate time that it will take the chosen wash cycle to complete.
- ✓ Select any program options by using the program option button underneath the LCD display (for more information, please refer to the "setting a program option" section).
  - Any program option that you select, will affect the length of time that the wash cycle will take to complete. The LCD display will update to reflect this change.
- ✓ Press the Start/Stop button.
  - After approximately 5 seconds, you will hear your washing machine start the wash cycle.

- **If there is a power failure or the plug is pulled out of the socket when a wash cycle is in progress. Once power has been restored, the wash program will continue.**
- Whilst the wash program is in progress, the time remaining to the end of the wash cycle will appear on the display.



- The active phases will appear at the top of the display, as the wash program progresses. The time remaining until the end of the program will update throughout the wash cycle. Please note that it does not count down in "real time".
- Any program option can be selected once the wash cycle is already in progress, providing that the stage in the wash cycle that the option will effect has not already passed. (E.g. you cannot select an intensive wash, once the machine has reached the rinse stage of the wash cycle).

### Selecting a separate drying program

- Select the most appropriate drying cycle for the garments that you wish to dry, by turning the program selector knob.
- **IMPORTANT: Please take note of the maximum size of load that you can dry in this appliance. This information is contained in the program chart.**

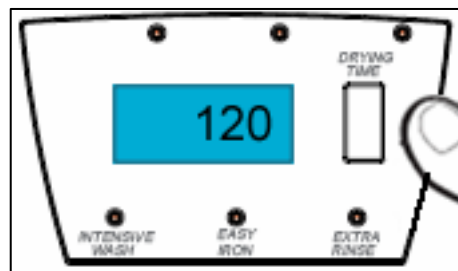

- Select the drying time in minutes, by using the drying time button.
- The drying time will appear on the LCD display and will increase each time the drying time button is pressed.
- Press the START/STOP button to get the drying cycle to commence.

## Selecting an automatic wash and dry program

- ✓ Select the most appropriate wash program for the garments that you are washing, by turning the program selector knob.
- The LCD display will briefly flash the wash program number that you have selected and then show the approximate time that it will take the chosen wash cycle to complete.
- ✓ Select any program options by using the program option button underneath the LCD display (for more information, please refer to the “setting a program option” section).
- Any program option that you select, will affect the length of time that the wash cycle will take to complete. The LCD display will update to reflect this change.
- Select the drying time in minutes, by using the drying time button.
- The drying time will appear on the LCD display and will increase each time the drying time button is pressed.
- Press the START/STOP button to get the automatic wash and dry cycle to commence.
- **IMPORTANT: If you select a wash and dry program, your wash load must not be over 4kg for NORMAL wash programs and 1.5kg for DELICATE wash programs.**

## Cancelling or pausing a wash program

- ✓ To stop a wash program once a wash cycle is in progress, you should turn the program selection knob.
- The appliance will go onto PAUSE status and the wash program will be cancelled.
- The door will remain locked for two minutes before it is possible to open the door and take out the garments.



**Before opening the porthole door, you MUST select the DRAIN program. Otherwise there may still be water in the drum when you open the door.**

- It is also possible to put the machine into PAUSE status by pressing the START/STOP button whilst the wash cycle is in progress. However this will not cancel the wash program and to restart the wash cycle, you should press the START/STOP button again.

### **Spin speed selection knob**

- To allow your washer dryer to automatically select the highest spin speed for the wash program that you have selected, you should turn the spin speed selection knob to 1100 rpm.
- If you then choose a delicates or wool wash program, the gentle spin speed will be selected by the washer dryer, even if the spin speed selection knob is pointing to 1100 rpm.
- However it is possible to decrease the spin speed that it automatically selects, by turning the spin speed selection knob.
- ✓ Turn the wash program selection knob to the wash program that you want to use.
- ✓ Turn the spin speed selection knob to the speed that you wish the washer dryer to spin at.
- The appliance will override your selection, if you turn the knob to a spin speed that is too high for the wash program that you have selected.
- If you turn the spin speed selection knob to 0, then the machine will not spin at all and will drain the water from the drum.
- If you turn the spin speed selection knob to "Anti-crease", then the clothes will be held in water, until you select a spin or drain program.
- **IMPORTANT: YOU MUST DO THIS BEFORE OPENING THE DOOR OF THE APPLIANCE.**
- This feature is useful if you are not going to be present when the wash cycle completes, as it will lessen the chance of the garments becoming creased.



**Please note that if you suspend the clothes in water, you must select a spin or drain program and not just cancel the program. Otherwise you could open the porthole door whilst there is still water in the drum.**



**You should ensure that the garments you are washing are suitable for suspending in water before selecting this option. Garments should not be suspended in water for a prolonged period.**

### Setting a program option

- There are three program options that you can select (providing that the wash program chart indicates that a particular option can be selected with a particular wash program).

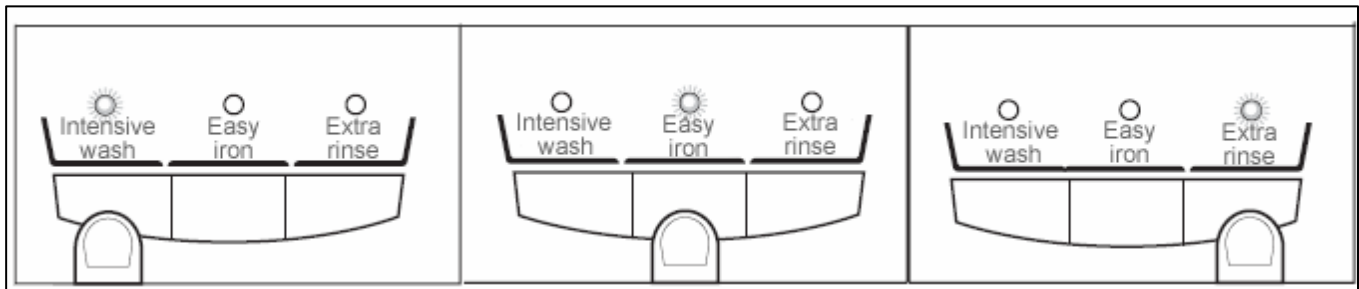

- To select a program option, you should press the appropriate program option button.
- A light will appear above the timer display, to indicate that which program option(s) you have selected.
- One, two or three program options can be selected at a time, depending on the wash program that you have selected.
- Any program option that you select, will affect the length of time the wash cycle will take to complete. The LCD display will update to reflect this change.
- ✓ Press the START/STOP button.
- The program option button needs to be pressed after a wash program has been selected, but before the wash program has been started. If you select a different wash cycle after pressing a program option, it will need to be reselected.
- Any program option can be selected once the wash cycle is already in progress, providing that the stage in the wash cycle that the option will effect has not already been passed. (E.g. you cannot select an intensive wash, once the machine has reached the rinse stage of the wash cycle).

## Maintenance and cleaning

### In daily use

- ✓ Once a wash cycle has completed, you should pull out the detergent drawer slightly, so it can dry out.
- ✓ Leave the porthole door ajar for a short while after a wash cycle has completed. This should help to prevent stagnant smells and to protect the door seal.
- ✓ Close the water tap.
- ✓ We suggest that you disconnect the appliance from your mains supply, when it is not in use.

### Control panel and washer dryer cabinet.

**IMPORTANT:** Do not use any abrasive cleaner or household polish on either the control panel or operating parts.

- ✓ Wipe over the control panel and the external surface of the machine using a brand new damp cloth with warm water.
- ✓ If you ever spill any liquid detergent or conditioner from the detergent drawer onto the washing machine cabinet, then these should be cleaned up immediately as they could be corrosive.

### Detergent drawer

Occasionally the detergent drawer should be cleaned.

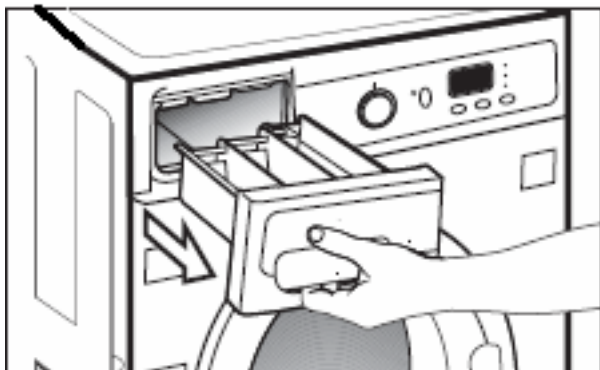

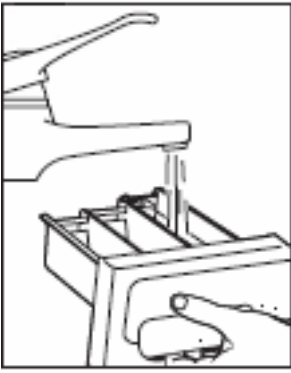

- Pull the detergent drawer out as far as it will go and then remove the drawer by pulling firmly.

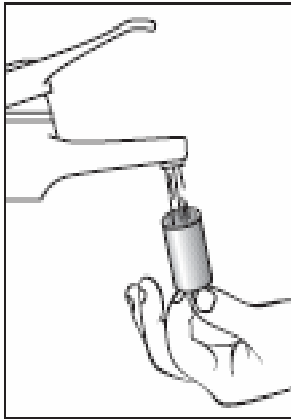

- Use warm water and a brush to thoroughly clean the three compartments of the detergent drawer.

- Clean the area that the detergent drawer slides into with a brush.



- You should also clean the siphon that sits inside of the conditioner  section of the detergent drawer. Taking care to make sure that the siphon is inserted back in the drawer correctly.
- Replace the detergent drawer by placing it back into the slot. Then push the drawer fully back into position.

## The washer dryer drum

The drum of your washer dryer is constructed from stainless steel. However if there are objects that can rust placed inside the drum, then it is possible for the drum to become stained.

**IMPORTANT:** Do not use a descaling agent, iron/steel wool or scouring agents to clean the drum of your appliance.

- ✓ Remove any rust stains on the drum with an appropriate stainless steel cleaning agent.

## Door

- ✓ You should regularly check to see if any deposits have formed, or there are any foreign bodies in the rubber door gasket. This sits inside the opening of the porthole door.

## Error code failure system

If your appliance senses that it is not operating correctly, then an error code may appear in the LCD display.

The following error codes can possibly be remedied by the customer and the steps outlined below should be followed.

**BEFORE COMPLETING ANY MAINTAINANCE ON THE APPLIANCE, IT SHOULD BE DISCONNECTED FROM YOUR MAINS POWER SUPPLY.**

### No display

- Power failure.
- Check that the power plug is in the mains socket correctly.
- Check the mains fuse.

### F01- No water coming into the machine

- Check the water pressure of your mains water supply.
- Clean the mesh filter that sits in the inlet hose.
- Make sure the water tap that the machine is connected to is turned on fully.

### F02- The machine will not drain or spin

- Clean the drain pump filter.
- Check the drain hose is not blocked or kinked.

### F04- The machine does not start

- Check that the door has been shut properly before commencing a wash cycle.

### C03- The machine has sensed an out of balance load

- This may be due to uneven distribution of clothes in the drum, which may cause an excessive level of vibration.
- See General troubleshooting section.

### F05 – F10- Contact Baumatic Service Department

Once the machine has been plugged back into your mains power supply, to clear the fault code from the LCD display, you should turn on the machine and hold down the Start/Stop button for approximately 5 seconds.

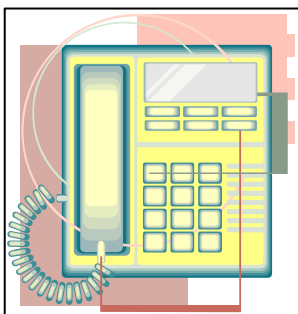

**If a fault code reappears after following the above advice and clearing the fault code. You should turn the wash program selection knob to the off position. Disconnect the appliance from your mains supply. Then arrange for an engineer to attend the appliance. You should contact the Baumatic Service Department on (0118) 933 6911.**



**IF AN ENGINEER ATTENDS DURING THE GUARANTEE PERIOD AND FINDS THAT A FAULT HAS BEEN CAUSED BY AN ITEM ON THE ERROR CODE LIST, WHICH COULD HAVE BEEN CLEARED BY THE CUSTOMER. THEN YOU MAY BE LIABLE FOR THE COST OF THE SERVICE CALL.**

## **General troubleshooting**

### **Water under the washer dryer**

- Tighten the drain pump filter.
- Check the drain and inlet hose and make sure that it is fully tightened.

### **Washer dryer vibrates during the spin cycle**

- Check that the transport locking devices have been removed (see installation instructions).
- Make sure that the washing machine is installed on a flat and level floor.
- Ensure that all four feet are resting firmly on the floor, by pressing down on each corner and making sure that the appliance is stable.
- If it is unstable then follow the "Positioning and leveling the appliance" section.

### **Poor spin results**

- Clean the drain pump (see "Cleaning the drain pump filter" section).

### **Water in the detergent dispenser**

- Although there will be some water residue left in the detergent drawer after a wash cycle has completed. If the drawer is full of water then you may need to clean the detergent drawer.

**IMPORTANT: Your appliance has an unbalance control system. If this system detects that the washload is unevenly distributed inside the drum. Your washer dryer will try to redistribute the load before spinning. If after several attempts it is unable to redistribute the washload, then the appliance will either spin at a slower speed or skip the spin cycle and drain.**

**Uneven load distribution can be caused by too large a wash load or too small a wash load. It can also occur if a single item is washed inside the appliance.**



**My garments are looking grey and there are limescale deposits present in the drum of my washer dryer.**

- There is not enough detergent being added.
- The incorrect detergent is being used.
- Stains are not being pre-treated.
- The correct wash program or wash temperature was not selected.



**I have followed the advice given above, but my garments are still coming out with grey stains on them.**

- The garments are soiled with oils, ointments or grease and were washed without enough detergent.
- The wash temperature selected was too low.
- Fabric conditioner has come into contact with the garments. If this happens try to wash out these stains as quickly as you can and try to avoid getting conditioner on the garments in future.



**After the final rinse, I can still see foam.**

- Modern detergents can result in there still being foam in the final rinse, this does not mean that the washing is not being rinsed properly.



**There is white residue on my garments when I remove them from the appliance.**

- Modern detergents can contain insoluble contents, and white residue after a wash cycle is not necessarily a sign of the garments not being rinsed properly.
- You should shake out the garment or brush it off. In future possibly turn the garment inside out before it is washed. You may wish to move from a powder detergent and switch to a liquid detergent instead.

## Cleaning the drain pump filter



**IMPORTANT:** Switch off your washing machine and disconnect the plug from your mains supply.

**You should clean out the filter approximately every twenty washes. If the drain pump filter is not cleaned regularly, then your appliance may find it difficult to pump out water efficiently.**

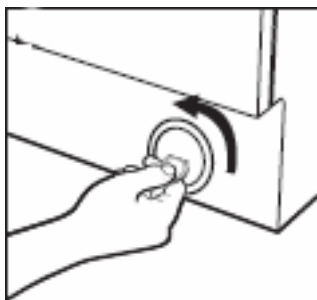

Remove the kickplate and then use a coin to turn the filter cap.

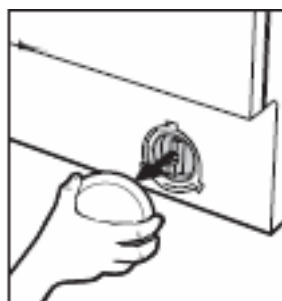

Pull out the filter cap.

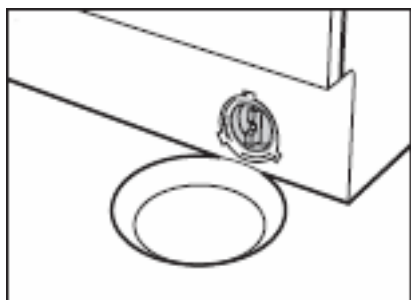

Place a container under the drain pump filter, to collect any excess water that may come out of the drain pump when it is removed.



Turn the filter a quarter turn anti clockwise, water will start to come out of the drain pump. Continue to turn the filter anti clockwise until you reach a half turn, more water will come out of the drain pump.

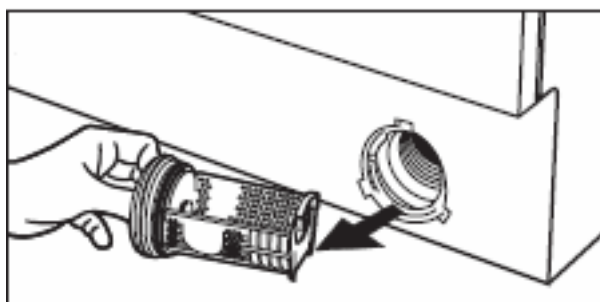

When all the water has drained out of the washing machine, turn the filter several times anti clockwise, until it can be removed completely.

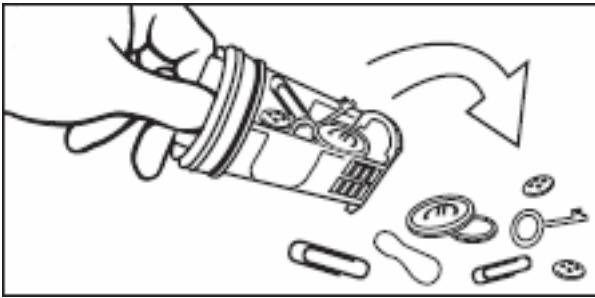

Remove the filter and rinse out the filter under the tap.

Remove any debris from the filter.

Remove any debris that is in the area of the appliance that you removed the drain pump filter from.

Screw the filter clockwise back into position, making sure that it is fully tightened. You should keep turning until you cannot turn it any further.

Refit the filter cap.

**IMPORTANT: Do not perform this operation if the appliance has stuck on a cycle, until the water inside the machine has cooled sufficiently. Otherwise the water that comes out of the drain pump filter may still be hot.**

## Installation



**IMPORTANT: THIS INSTALLATION MUST BE COMPLETED BY A SUITABLY QUALIFIED PERSON. BAUMATIC ONLY SANCTION THE INSTALLATION GIVEN IN THIS INSTRUCTION MANUAL. YOU SHOULD KEEP THE TRANSIT PACKAGING, IN CASE YOU NEED TO TRANSPORT THE MACHINE IN THE FUTURE.**

### Unpacking the machine and removing the transit bolts

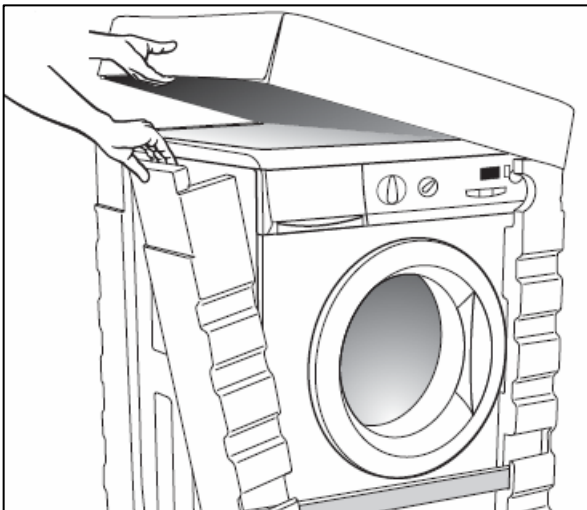

- ✓ Remove the base, corner protection pieces and top cover.

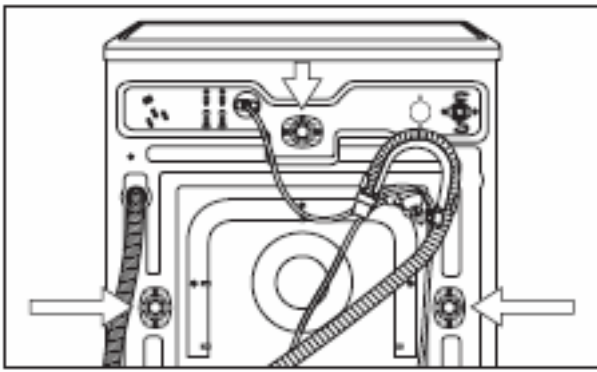

- ✓ Locate the three transit bolts that secure the drum in position, whilst the appliance is being transported.

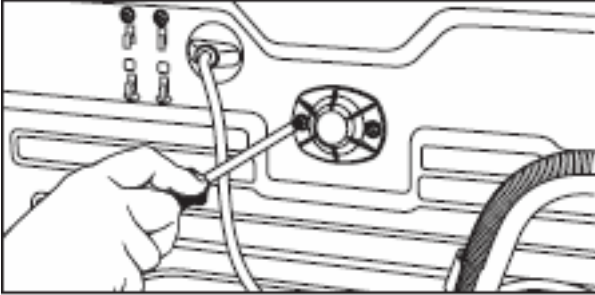

- ✓ Using a screwdriver, unscrew the three plastic transit bolt covers.

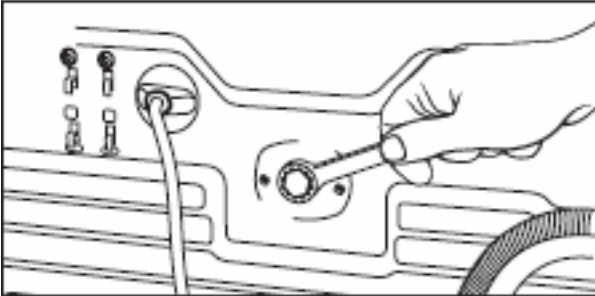

- ✓ Loosen and remove the three transit bolts.

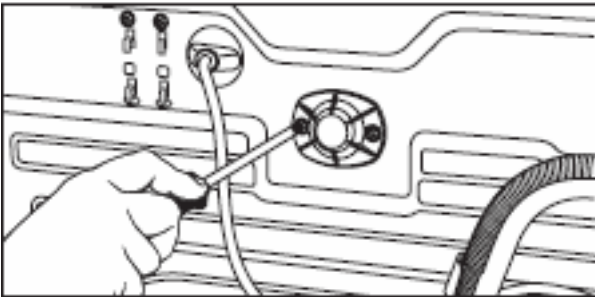

- ✓ Using a screwdriver, refit the three plastic transit bolt covers that you removed previously.

**IMPORTANT:** The transit bolts **MUST** be removed before your washing machine is used for the first time.

## Positioning and leveling the appliance

- ✓ Place the washing machine on a solid and level floor surface.
- ✓ **DO NOT PLACE THE WASHING MACHINE ON A CARPET.**

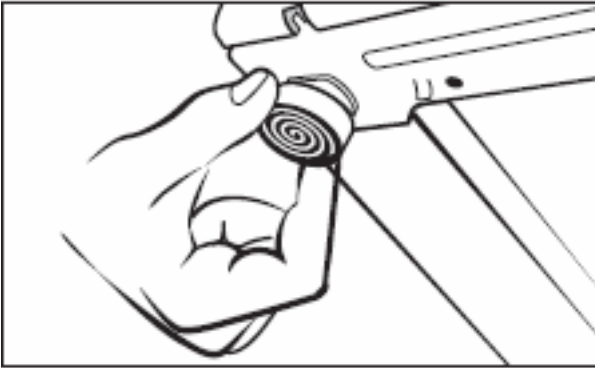

- ✓ Loosen the adjustable feet that are positioned on the base of the appliance.

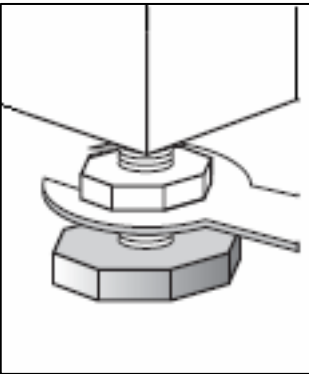

- ✓ Slacken off the lock nut on each of the washing machine feet using a spanner.

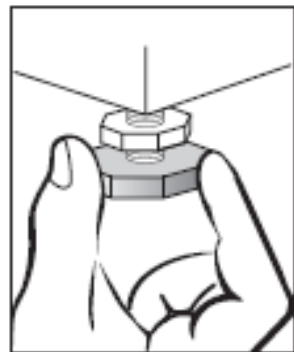

- ✓ Adjust the feet to level off the washing machine.

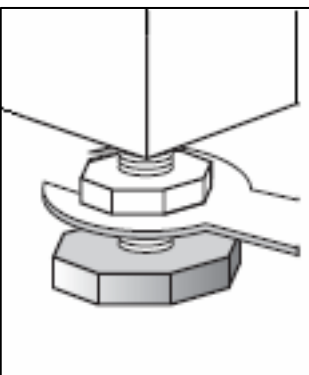

- ✓ Once leveled correctly, you should tighten the lock nut back up on each of the washing machine feet using a spanner.

**IMPORTANT:** When the washing machine is positioned in the location where it will be used. Make sure that all four feet are resting firmly on the floor, by pressing down on each corner and checking that the appliance stands still.

## Connecting to the mains water supply

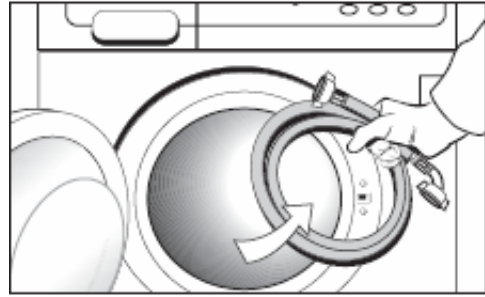
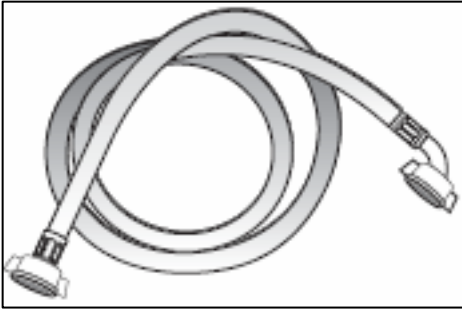

- ✓ The water inlet hose will be inside the drum of your washing machine, when you receive the appliance.

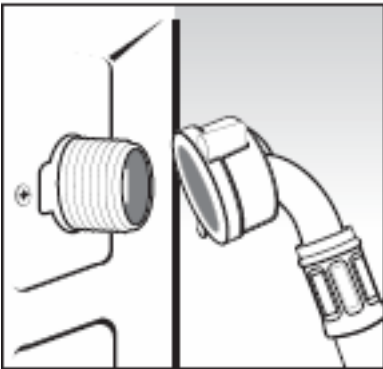

- ✓ Connect and fully tighten the inlet hose to the threaded inlet valve that is located at the rear of the washing machine. You should connect the end with the right angle connector on it to the back of your appliance.



- ✓ Connect the other end of the inlet hose to your mains water supply

- ✓ **IMPORTANT:** There should be a filter sitting inside the end of the inlet hose that connects to your mains water supply. The inlet hose may leak if this filter is missing. This filter is supplied with the appliance, you should contact Baumatic to obtain one, if it is missing.
- ✓ Tighten the inlet hose to your mains supply fully, but do not over tighten as this may distort the filter that sits in the end of the inlet hose.
- ✓ Test for any leaks.

## Water outlet

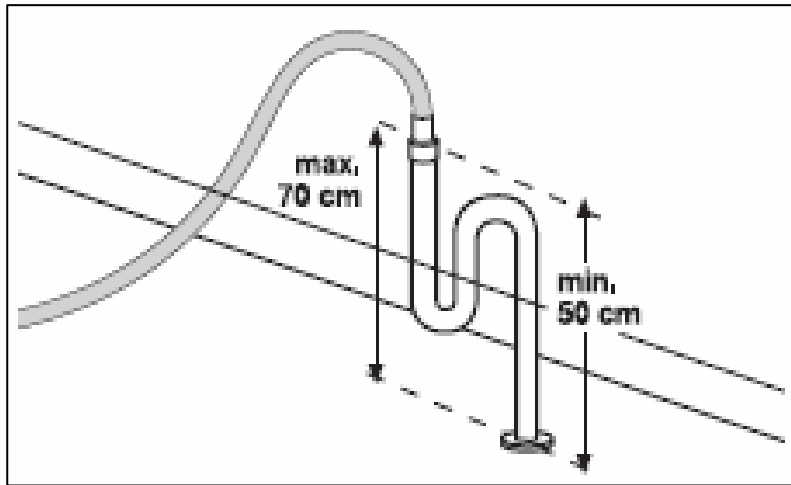

- ✓ Secure the drain hose, so that it cannot move whilst the washing machine is in use.
- ✓ Place the end of the drain hose on your drain pipe. Push it a short way down into your drain pipe.
- ✓ **IMPORTANT:** Do not insert the drain hose too deeply into the water pipe, as this may cause siphoning.
- ✓ **NEVER EXTEND THE DRAINAGE HOSE FROM ITS ORIGINAL LENGTH.**

## Power supply

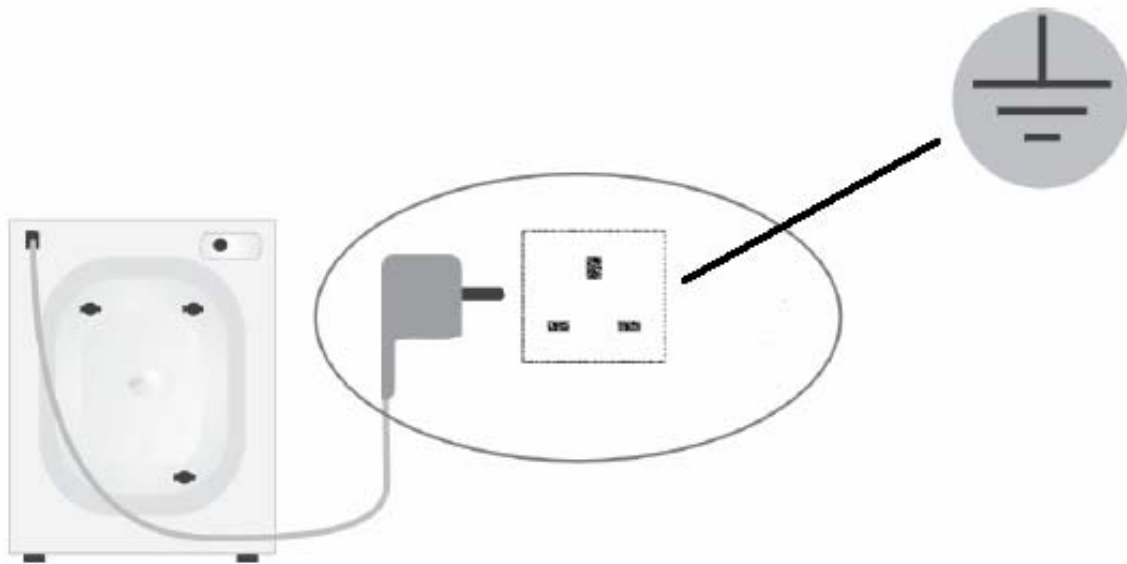

- ✓ **IMPORTANT:** The electrical socket must still be accessible once the appliance is installed.

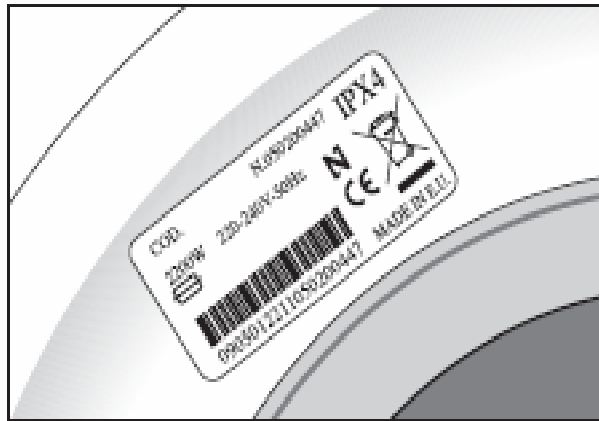

- ✓ Consult the rating plate, located on the inner rim of the porthole door of the appliance **BEFORE** making the electrical connections. Ensure that the voltage reaching the plug, is the same as that on the rating plate.

- ✓ **DO NOT REMOVE THE RATING PLATE AS THE INFORMATION ON IT IS IMPORTANT.**
- ✓ The moulded plug that is supplied with the appliance must be placed into an earthed and insulated socket.
- ✓ Broken or damaged power leads must only be replaced by a suitably qualified person. A power lead of a similar type must be used in replacement.
- ✓ Power lead type – H 0 V V – F 3G 1,5.
- ✓ **IMPORTANT:** We do not recommend that this appliance is connected to an extension lead.

## Before first use maintenance wash



- When your washer dryer has been correctly installed, we recommend that you perform a maintenance wash cycle.
- This will check that all aspects of the installation are correct; it will also remove any deposits that may have been left on the drum by the manufacturing process.
- Select a Normal 90°C wash program.
- A small quantity of detergent should be used during this maintenance wash.

### Certificate of compliance **CE**

Compliance with the following Directives: 73/23/EEC, 89/336/EEC, 92/75/EEC  
The Manufacturer declares that its product complies with the general safety, hygienic and environmental protection requirements pursuant to the European Community Directives and that the specific documents applicable to the said product, especially the European Community Declaration of Conformity issued by the manufacturer may be viewed in offices of the competent authorities and may be obtained through the Manufacturer.



*You will be mine ...*

**United Kingdom**

Baumatic Ltd.,  
Baumatic Buildings,  
6 Bennet Road,  
Reading, Berkshire  
RG2 0QX  
United Kingdom

**Sales Telephone**

(0118) 933 6900

**Sales Fax**

(0118) 931 0035

**Service Telephone**

(0118) 933 6911

**Service Fax**

(0118) 986 9124

**Spares Telephone**

(01235) 437244

**Technical Advice Telephone**

(0118) 933 6933

**E-mail:**

sales@baumatic.co.uk  
technical@baumatic.co.uk

**Website:**

www.baumatic.co.uk

**Republic of Ireland**

01- 6266 798

**Czech Republic**

Baumatic CR spol s.r.o.  
Amperova 495  
46215, Librec  
Czech Republic

+420 800 185 263

www.baumatic.cz

**Slovak Republic**

Baumatic Slovakia, s.r.o.  
Skultetyho 1  
831 04 Bratislava 3  
Slovakia

+421 255 640 618

**Germany**

Baumatic Gmbh  
Janderstrasse 9  
Mannheim, 68199  
Germany

+4962 112 9190

www.baumatic.de

**Italy**

Baumatic Italia S.R.L.  
Via Caltana 129  
Campodarsego (Padova), 35011  
Italy

+3904 9920 2297

www.baumatic.it

**Holland**

Baumatic Benelux B.V.  
Grindzuigerstraat 22  
1333 MS ALMERE  
The Netherlands

+3136 549 1555

www.baumatic.nl



**Baumatic®**

[www.baumatic.com](http://www.baumatic.com)